

Sichtschutzelemente aus Aluminium in seiner edlen Form

2022

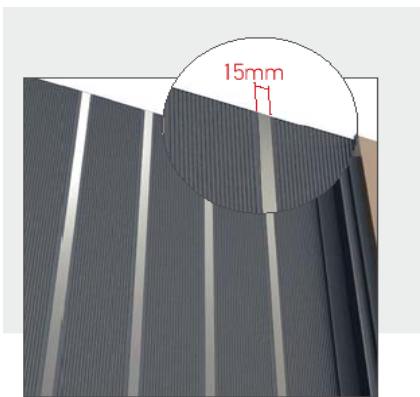

Abgestimmte Profile aus Aluminium für Sichtschutzelemente

mit dekorativen aluminiumeloxierten Streifen
Anordnung senkrecht bzw. waagrecht
beliebig erweiterbar
Pulverbeschichtung in vielen Farben
umfangreiches Zubehör
Sichtschutzprofile sind auf der einen Seite geriffelt
auf der anderen Seite glatt

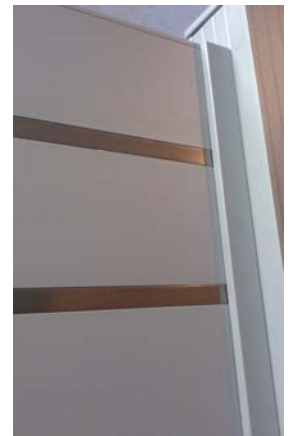
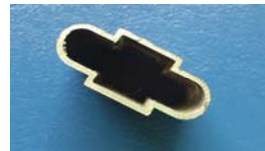



Seite mit geriffelter Optik

Seite mit glatter Optik

Sichtschutz geriffelt mit ovalem Profil im edelstahl Look eloxiert

benötigtes Material für ein Element 1,80m breit x 1.825m hoch mit waagerechten Streben:

Nut-Profil ist 10 cm breit eloxiertes Profil sichtbar 1,5 cm

Alternative: Sichtschutz wahlweise auch mit senkrechten Streben



Nut - Profil geriffelt einseitig:
100 x 15 mm

Art.nr: 070 - 009
16 x 1,80 m



Ovales eloxiertes Profil:
34,6 x 15 mm

Art.nr: 070 - 019
15 x 1,80 m

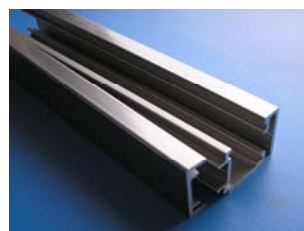

Seitliches U-Profil
25 x 30 mm

Art.nr: F50-310
x 1,80 m
mit Abdeckung 2



Alternative:

Seitliches U-Profil

2 x 1,8 m

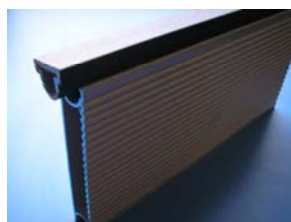

Abdeckung:

Art.nr: 070-0K9
1 x 1,80 m



Sichtschutz System 2



Seite 1 mit geriffelter Optik

Seite 2 mit glatter Optik

2022

Sichtschutz aus Nut - Feder Profil

benötigtes Material für ein Element 1,80m breit x 1.80m hoch mit waagerechten Streben wahlweise auch senkrechte Anordnung der Profile:



Nut - Profil geriffelt einseitig
sichtbare Breite 10 cm:

Art.nr: 070 - 011

18 x 1,80 m

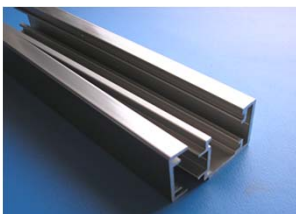
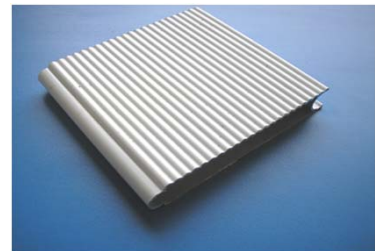

Seitliches U-Profil

Art.nr: F50-319

mit Abdeckung
2 x 1,80 m











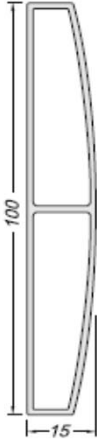
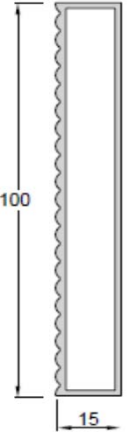
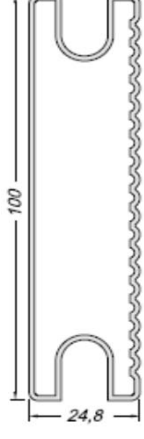
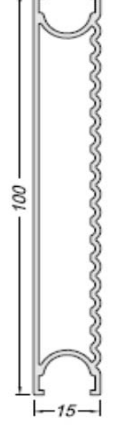
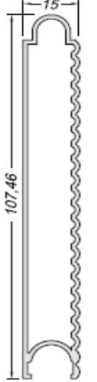

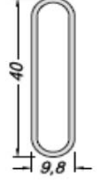



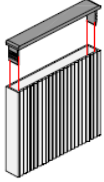

Abdeckung:







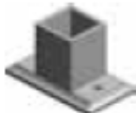
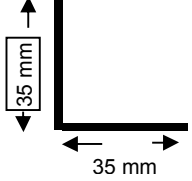
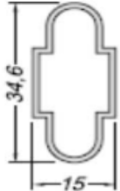

Art.nr: 070-0K9

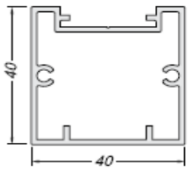
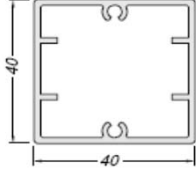
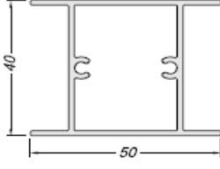
1 x 1,80 m

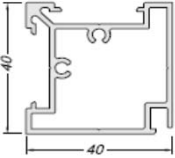
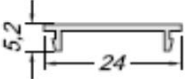

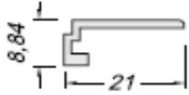
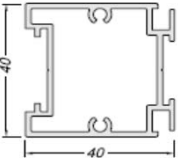
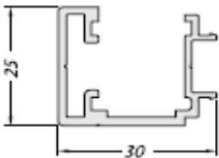
<p>Art.Nr:070-002</p>  <p>Alubrett einseitig gebogen 100x15 mm Gewicht 789gr/m</p>	<p>Art.Nr: 070-005</p>  <p>Vierkantprofil einseitig geriffelt 100x15 mm</p>	<p>Art.Nr:070-008</p>  <p>Alubrett einseitig geriffelt mit Nut 100x24,8 mm 996gr/m</p>	<p>Art.Nr: 070-009</p>  <p>Alubrett einseitig geriffelt mit Nut 100x15 mm 818 gr/m</p>
<p>Art.Nr: 070-011</p>  <p>Alubrett einseitig geriffelt mit Nut u. Feder 837 gr/m</p>	<p>Art.Nr: 070-022</p>  <p>Alubrett glatt mit Nut und Feder 100x15mm 788gr/m</p>	<p>Art.Nr: 070-023</p>  <p>Alubrett einseitig geriffelt mit Nut 100x15 mm 826 gr/m</p>	<p>Art.Nr: 510-918</p>  <p>Ovales Profil auch in eloxiert 40 x 9,8mm 283 gr/m</p>
<p>Art.Nr: 070-028</p>  <p>Alubrett glatt 120x15 mm 1166gr/m</p>	<p>Art.Nr: 070-029</p>  <p>Alubrett einseitig geriffelt 120x15 mm 1072gr/m</p>	<p>Art.Nr: 070-030</p>  <p>Alubrett 150x15 mm 1391gr/m</p>	<p>Stand 01.01.2022</p> <p>Profile in 6 m Längen</p> <p>Zuschnitt möglich</p> <p>Pulverbeschichtung in vielen Farben</p> <p>Holzähnliche Beschichtung</p> <p>technische Änderungen vorbehalten</p>

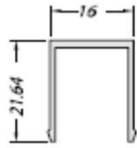
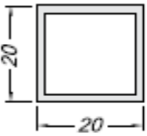
<p>Art.Nr:4472</p>  <p>Deckel aus Aluguss für Profil 070-005</p>	<p>Art.Nr: 300</p>  <p>Deckel 60x20</p>	<p>Art.Nr:303</p>  <p>Deckel 110x24</p>	<p>Art.Nr: 302</p>  <p>Deckel 20x20</p>
<p>Art.Nr: 299</p>  <p>Verbindung schwarz für Profil 070-002</p>	<p>Art.Nr: 298</p>  <p>298</p> <p>Deckel schwarz</p>	<p>Art.Nr: 4484</p>  <p>Deckel für Profil 070-030</p>	<p>Art.Nr: 297</p>  <p>Kunststoffdeckel für Profil</p>
<p>Art.Nr: 4118</p>  <p>Anschraubfuß</p>	<p>Art.Nr: 4113</p>  <p>Anschraubfuß</p>	<p>Art.Nr:P40-033</p>  <p>Winkelprofil 35 x 35 x 3 mm</p>	
<p>Art.Nr: 070-019</p>  <p>Ovales Profil in alu eloxiert 259gr</p>	<p>Art.Nr: 070-0K9</p>  <p>Abdeckung 165gr</p>	<p>Art.Nr: U-311</p>  <p>Leiste für die Aufnahme der Sichtschutzelemente 20x16x20 stärke 2 Länge 2m</p>	<p>Stand ab 01.01.2022</p> <p>Profile in 6 m Längen.</p> <p>Zuschnitt möglich</p> <p>Anfertigung auf Maß</p> <p>Beschichtung in vielen Farben</p> <p>Holzähnliche Beschichtung.</p> <p>passende Tore</p> <p>technische Änderungen vorbehalten</p>

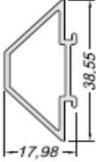
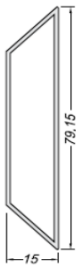
<p>Art.Nr:998-104</p>  <p>Pfosten 40x40 Gewicht 783gr/m</p>	<p>Art.Nr: F50-106</p>  <p>Pfosten 40x40 794gr/m</p>	<p>Art.Nr:070-001</p>  <p>Pfosten 50x40 772gr/m</p>	<p>Art.Nr: PAT29-047</p>  <p>Pfosten 40x40x1,5 624 gr/m</p>
<p>Art.Nr: 998-105</p>  <p>Eckpfosten 40x40 840 gr/m</p>	<p>Art.Nr: 971</p>  <p>Deckel für Pfosten 998-105 108 gr/m</p>	<p>Art.Nr: 994-910</p>  <p>Deckel für Pfosten 116gr/m</p>	<p>Art.Nr: 998-902</p>  <p>Deckel für Pfosten 998-102 u. 998-105 126gr/m</p>
<p>Art.Nr: 998-102</p>  <p>Pfosten 40x40 821gr/m</p>	<p>Art.Nr: F50-319</p>  <p>Glasgurt für 10-12mm 687gr/m</p>	<p>Art.Nr: F50-3K19</p>  <p>Deckel für Glasgurt F50-319 160 gr/m</p>	<p>Art.Nr: F50-311</p>  <p>Deckel für Glasgurt F50- 319 176 gr/m</p>
<p>Art.Nr: PAT29-008</p>  <p>Vierkant 20x20x1,5 300gr/m</p>	<p>Art.Nr: PAT59-10</p>  <p>Vierkant 60x20x1,5 624gr/m</p>	<p>Art.Nr: 992-901</p>  <p>Distanzprofil 329gr/m</p>	<p>Art.Nr: 992-401</p>  <p>Querprofil 79,15x15 536gr/m</p>

Art.Nr:CLS 100

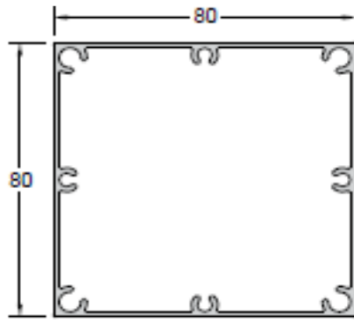

Pfosten 80x80
gewicht: 1606 gr/m

Art.Nr: 4485

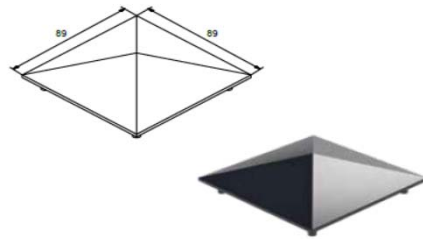

Pyramidendeckel für den
Pfosten 80x80 CLS 100
89x89

Art.Nr: 4621

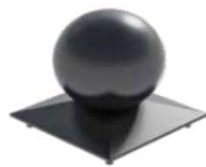
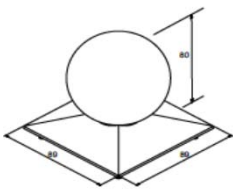

Deckel mit Kugel für den
Pfosten 80x80 CLS 100
89x89x80

Art.Nr: 4486

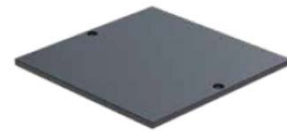
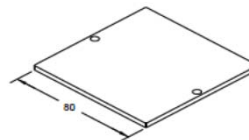

Deckel flach für den CLS
100
80x80

Art.Nr: 4721

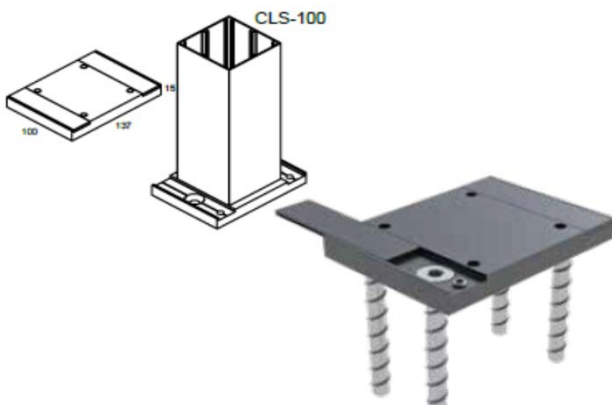

Aufgesetzte Verankerung für den
Pfosten CLS 100
100x137x15
incl. 4 x Schrauben

Art.Nr: 4722

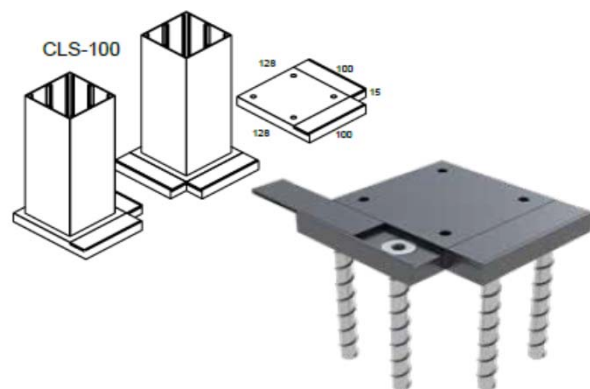

Aufgesetzte Eckverankerung für
den Pfosten CLS 100
128x100x128x100x15
incl. 4 x Schrauben